

JMRV5000PCFD	Sym.	Description	Rev. No.	Date	Confirmed by		
	△						
	△						
	△						
	△						
A	No.	Parts No.	Parts Name	Material	Spec.	Weight	Remark

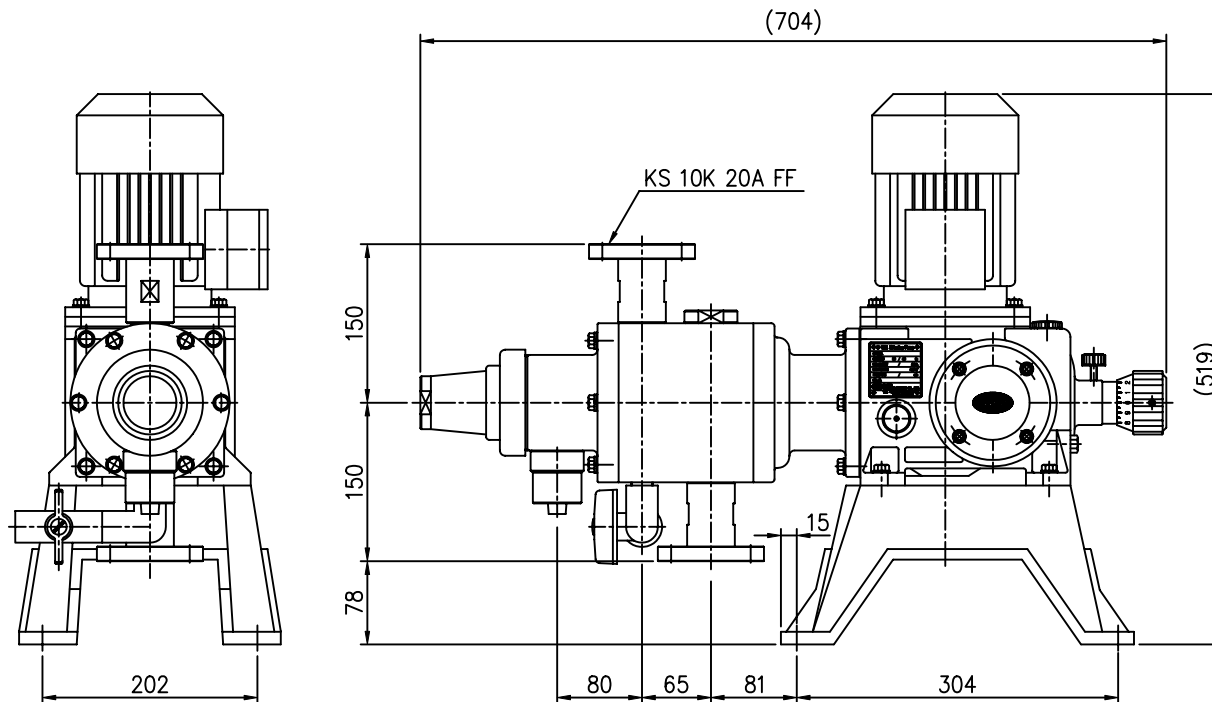

이 도면은 (주)이화정량펌프의 기술 자산입니다. 불법 유출시 관계법과 회사 규정에 의해 처벌 됩니다.

Projection		Trigonometry		Drawing Name	DIMENSIONAL OUTLINE
Scale	N / S	Unit	mm		
Drawn by	Designed by	Checked by	Approved by	Application	JMRV5000PCFD-20A FF
2004.02.21 H.J.SEO	W. PARK	W. PARK	S.C. KIM	Drawing Number	B0007E3040